

Experience with smart operation of ULTDH Booster

Substation for multifamily building

Jan Eric Thorsen, Marek Brand, Oddgeir Gudmundsson
Danfoss A/S - Heating Segment Application Centre



Part of project:
www.energylabnordhavn.dk



Funded by:



Field Location and Installation:



The Basic Concept ULTDH Heat Booster Substation:

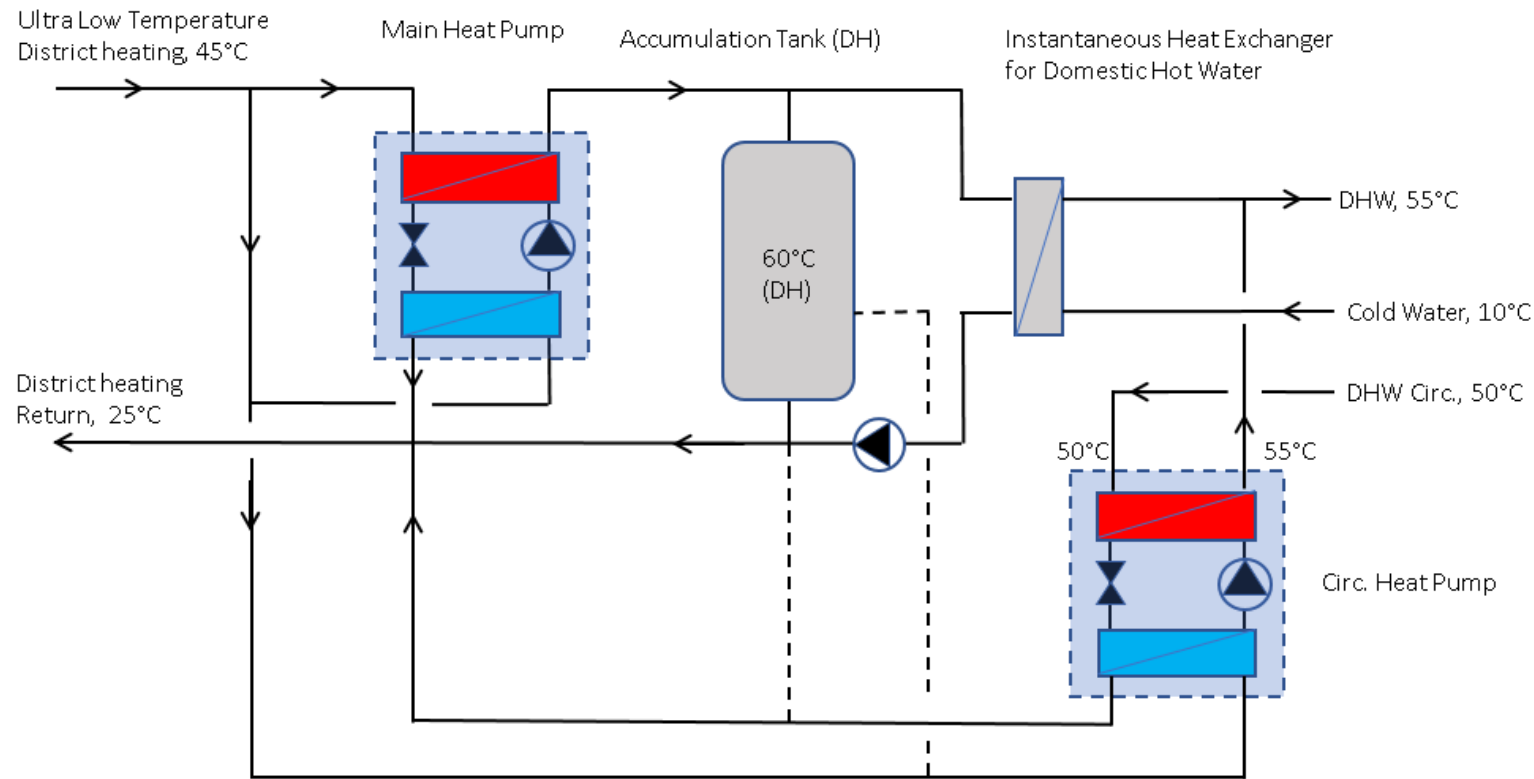

Flexibility 1:

Time of DH tank charge
-DH and Elec. load shift

Flexibility 2:

MHP evaporation temp.
-DH and Elec. fuel shift
-DH return temp.

Flexibility 3:

Source for Circ. HP
-DH return temp.

IN FOCUS:

Flexibility 1



HBS Charging profile:

5 charging periods
Triggered by energy costs
(min. duration 15 min.)

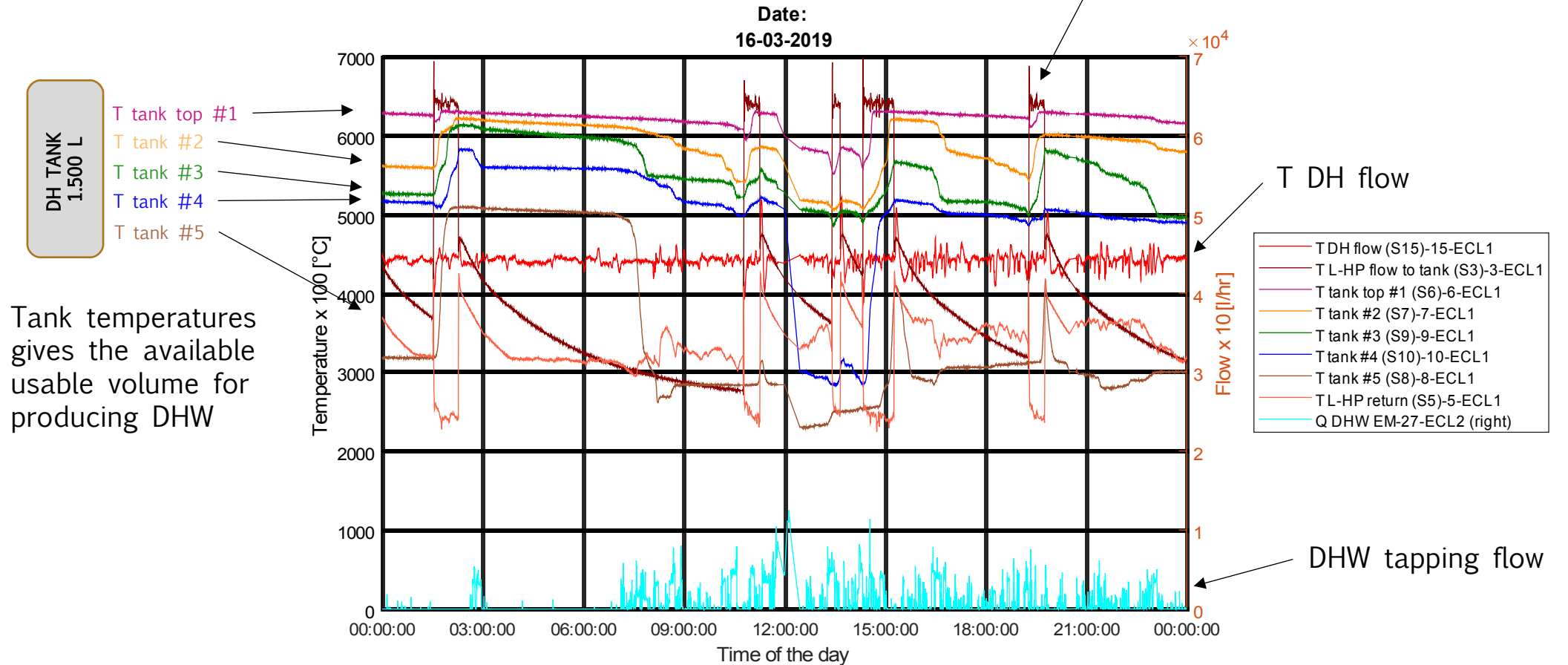

DHW demand patterns over the day:

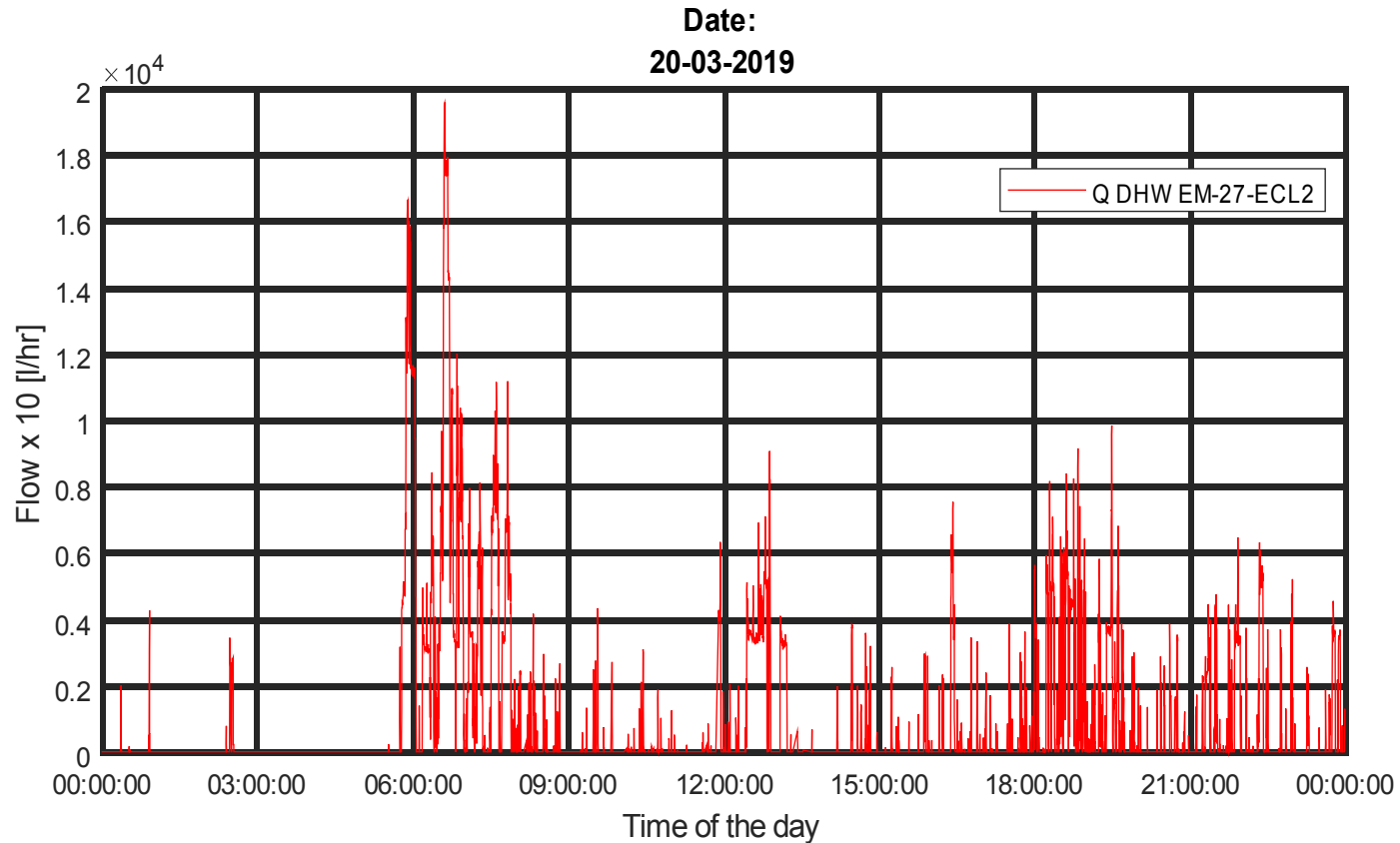

A Wednesday
Sample time 10 sec !
(8.640 data/day)

How to forecast tomorrow ?
Or maybe the next coming Wednesday ?
What about seasonal variations ?



DHW demand patterns over the day:

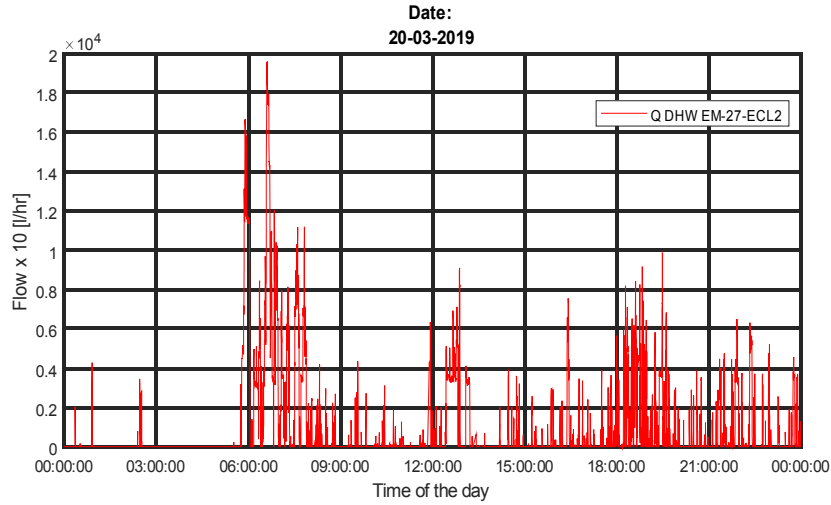

A Wednesday
2.200 Liters DHW produced
Sample time 10 sec !
(8.640 data/day)

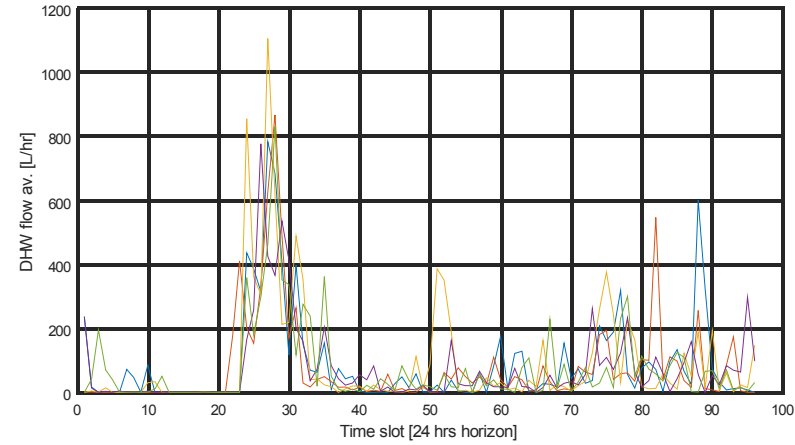

Aggregated data
Monday - Friday

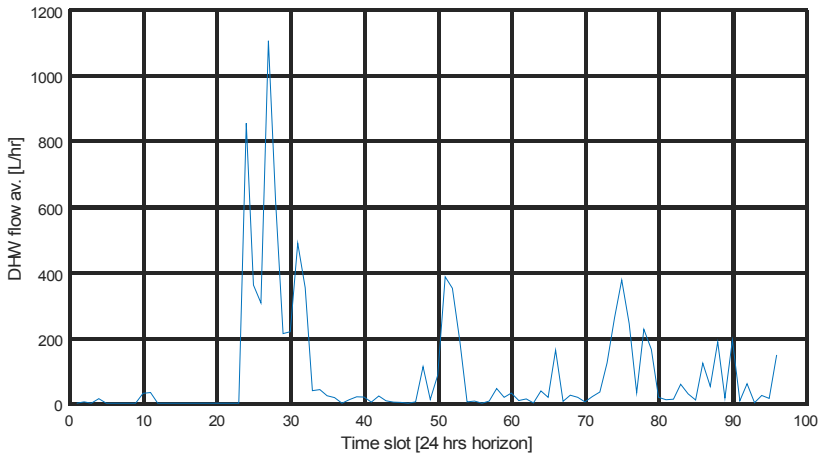

Aggregated data
into 96 slots (15 min)

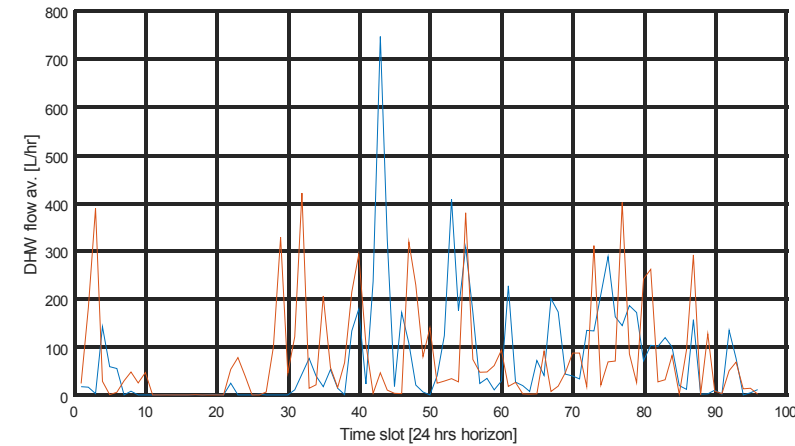

Aggregated data
Saturday - Sunday



DHW tapping volume pr. Day:

(55°C produced by HBS)



Data for 1 year and 4 months

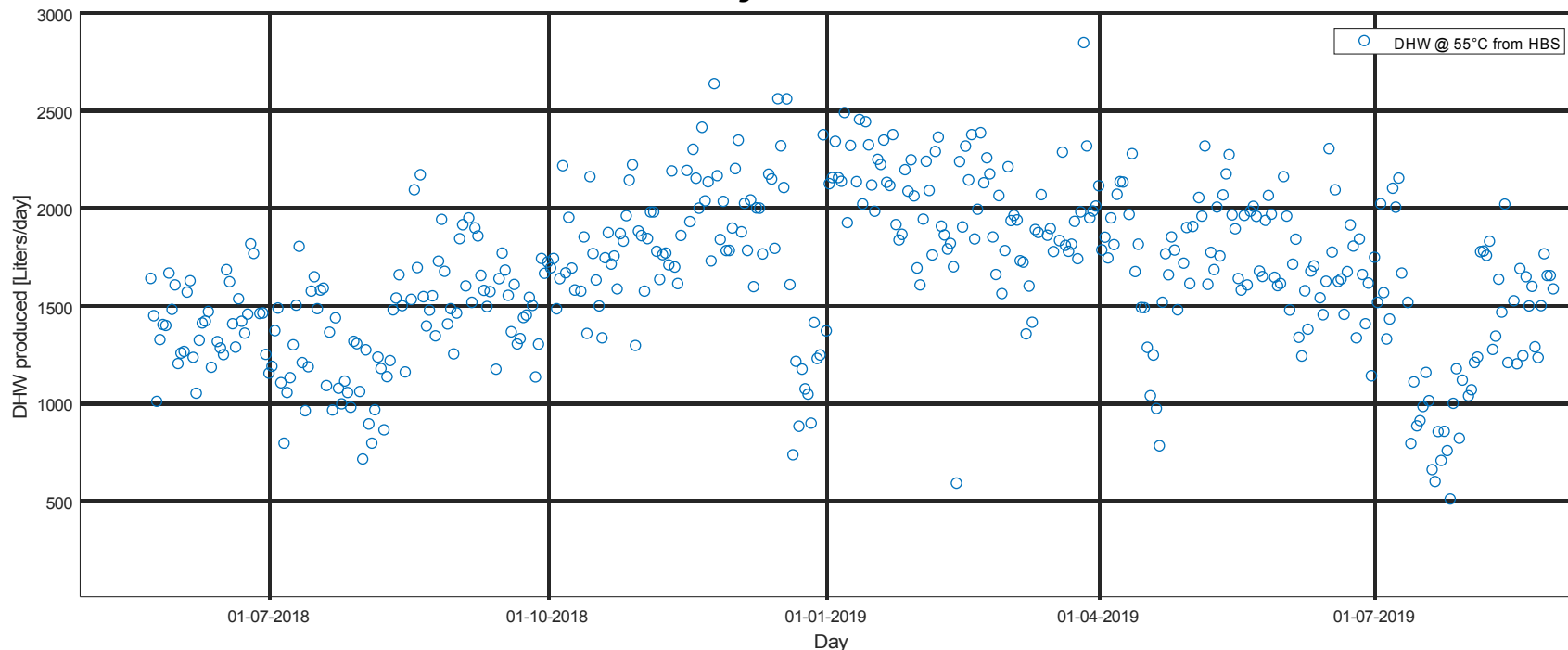

Seasonal variation of DHW consumption !

- > Ambient temperature !
- > Cold water temperature, due to mixing at tap/shower !
- > Alternative places to use DHW, e.g. vacation !



Seasonal trend good to know !



DHW tapping volume pr. Day:

(55°C produced by HBS)

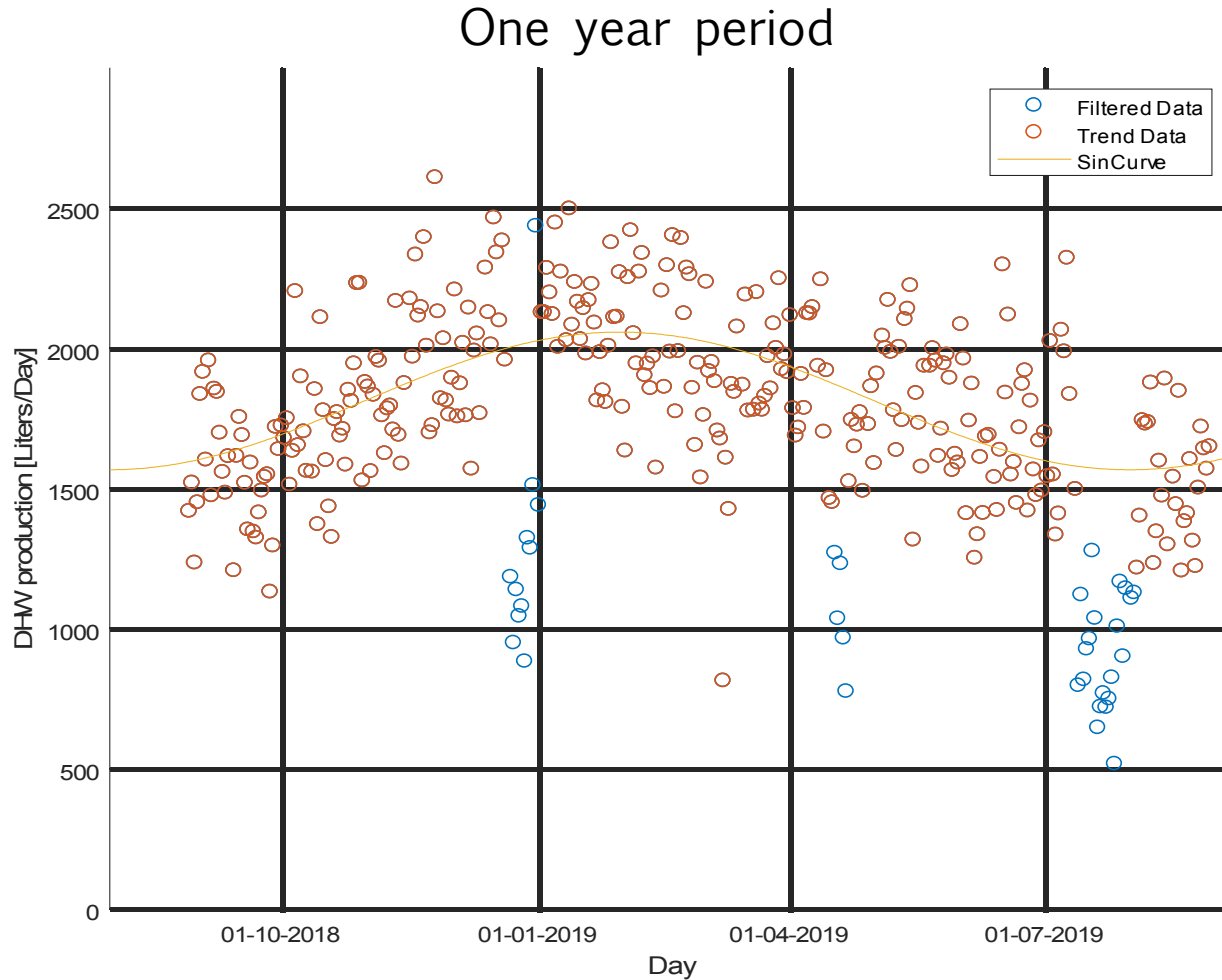

Trendline (SineCurve)

DHW Volume average: 1.800 liters/day
Trend curve amplitude: 250 Liters
Variation between days +/-500 liters/day



Principle of forecasting:

- Distinguish between the 7 days of the week
- Monday learns from Mondays, Tuesday learns from Tuesdays,.....
- Seasonal trend is learned from data of all days

Lets use a Wednesday as example, 3 Wednesdays in a row: W1,W2 and W3

How to forecast W3 based on W1 and W2:

WF = 0,25 (ForeCast is factored by 0,75 and ActualData by 0,25)

Passed W1: $W2_FC = W1_AD$

Passed W2: $W3_FC = W2_FC*0,75 + W2_AD*0,25$

Passed W3: $W4_FC = W3_FC*0,75 + W3_AD*0,25$

...

Day forecast is divided into 15 minutes intervals, to cover the daily variation
Forecast is first normalized by compensating for yearly variation
Then de-compensated by adding the yearly variation



DHW Actual, Forecast and Error pr. day:

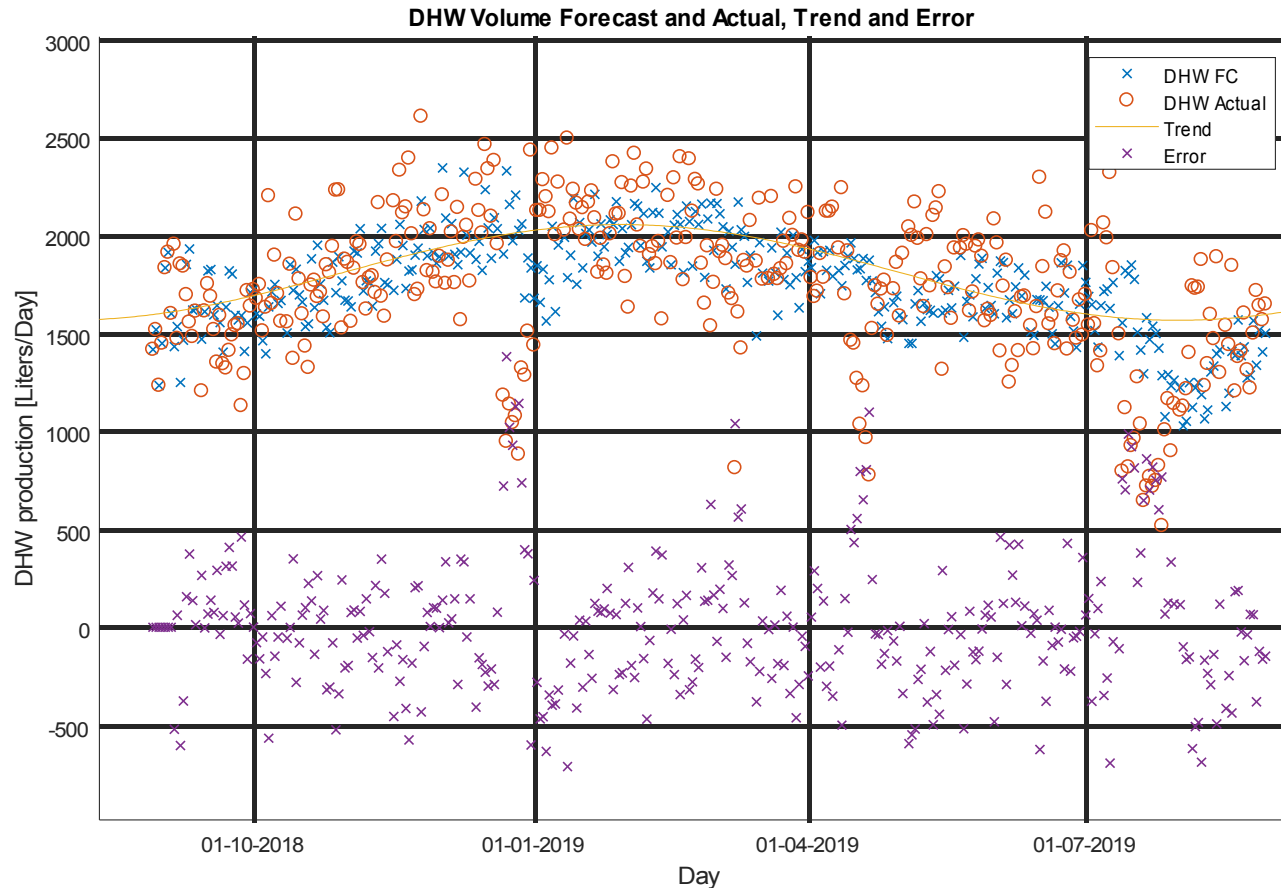

Error is in average around 0 (seasonal compensation)

First order filtration can be seen (Less variation around Trend for FC compared to AC)

Some outliers due to data issues filtered away (<500 Liters/day)

Christmas holiday, Easter holiday and summer holiday is "noise" or should be handled better !

WF=0,25



Impact of weighting factor:

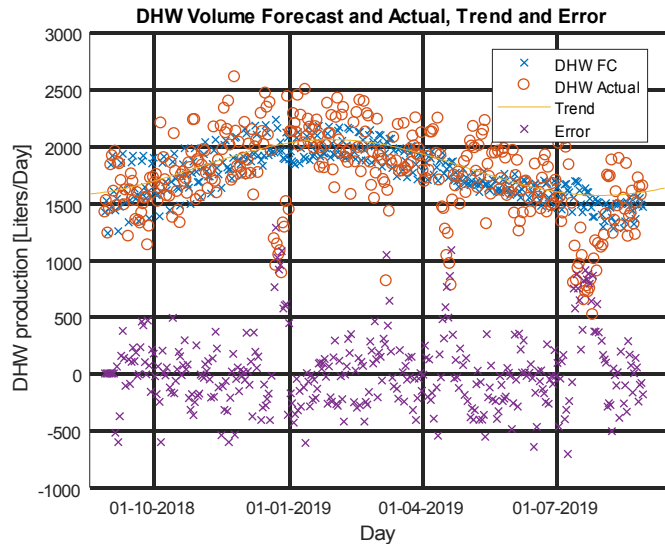

WF=0,10
Seasonal Comp.
(SineCurve)

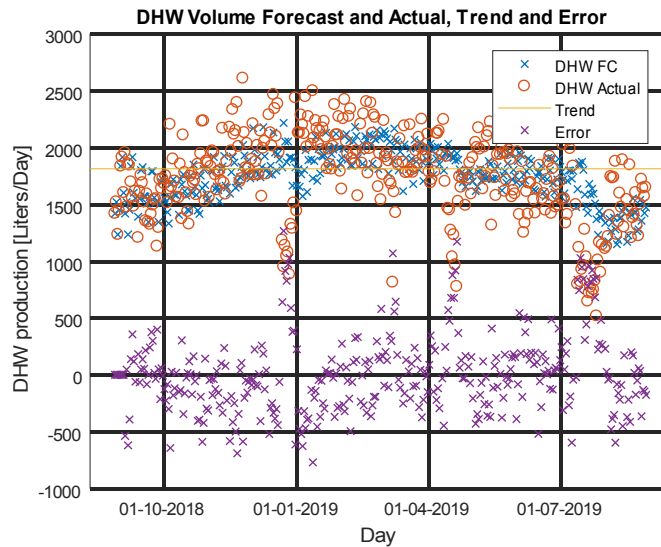

WF=0,25
NO Seasonal Comp.
(Straight line)

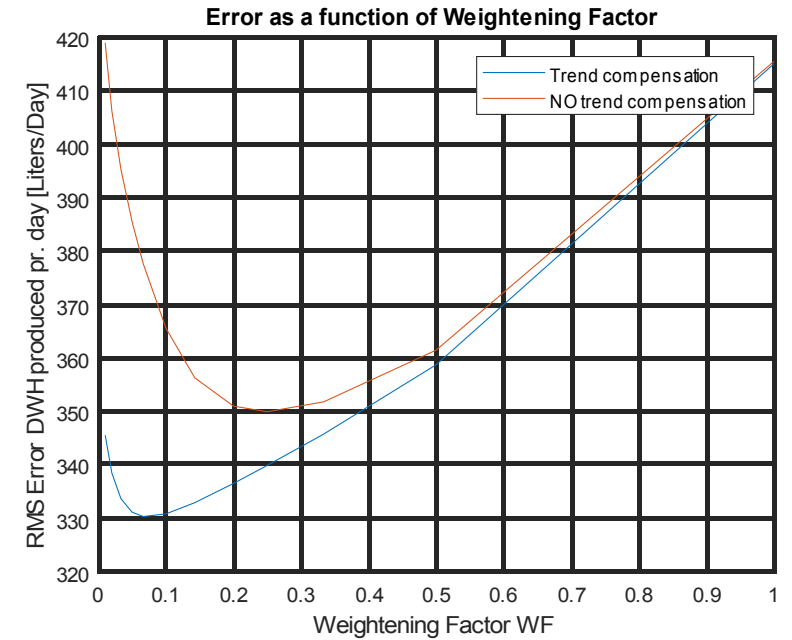

DHW Actual, Forecast pr. Day examples

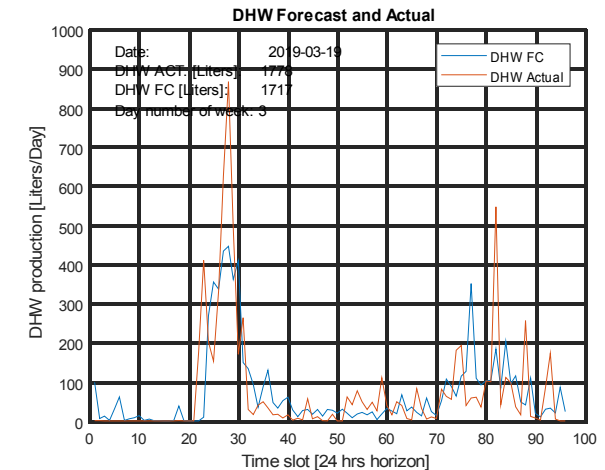
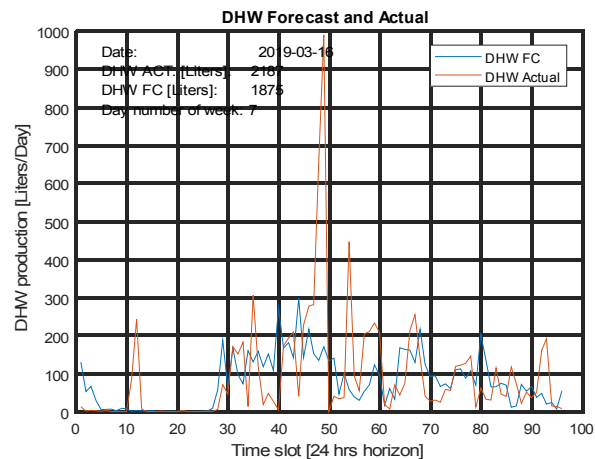
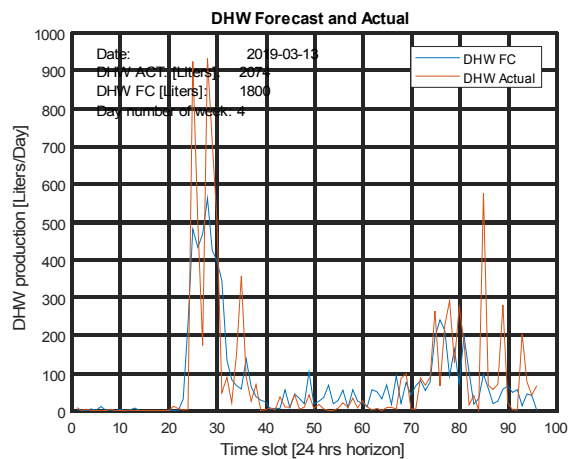
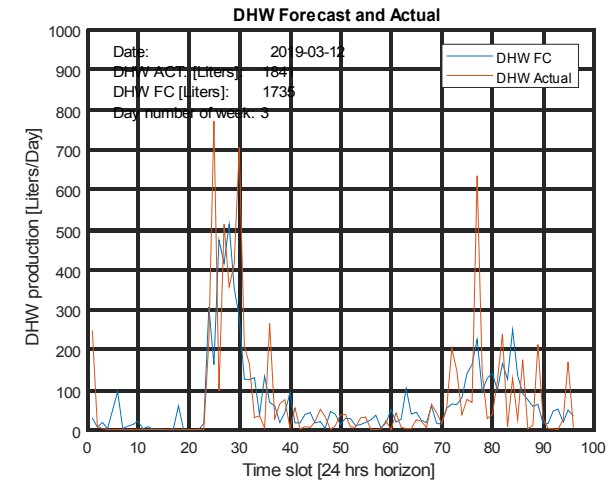
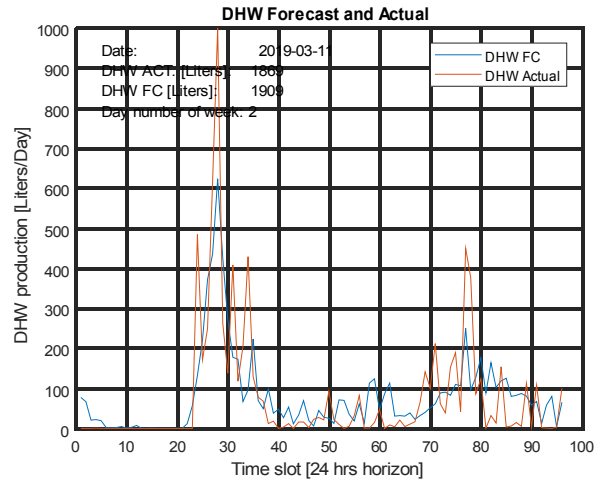
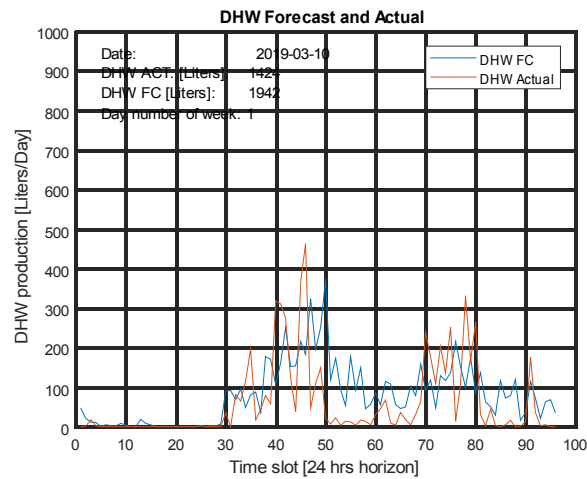

Day No 1 = Sunday, Day No 2 = Monday, Day No 3 = Tuesday and so on...



How big is the flexibility in terms of energy

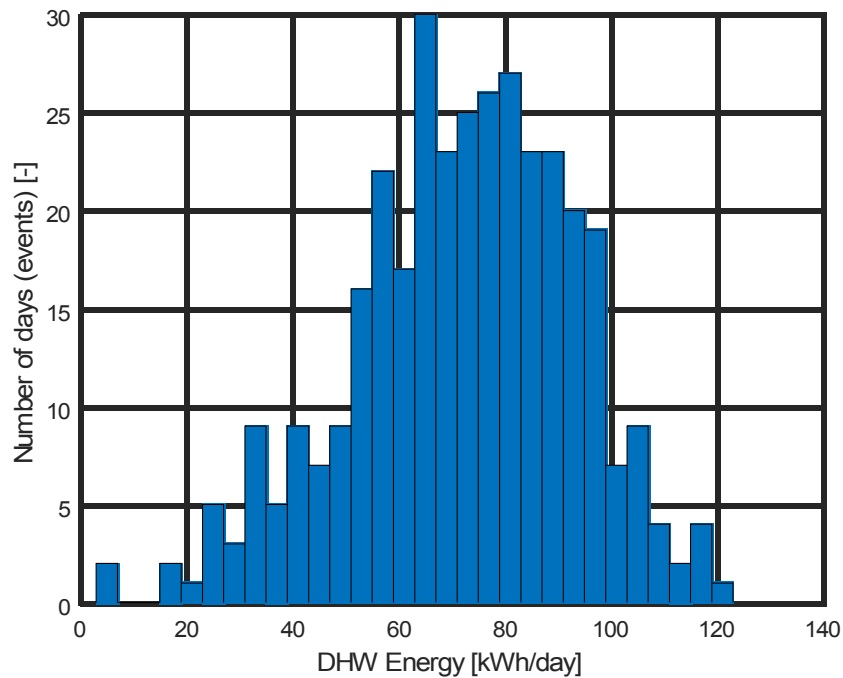

DHW 72 kWh/Day
average

DH flexibility $72 - 6,5 = 65,5$ kWh/Day
average

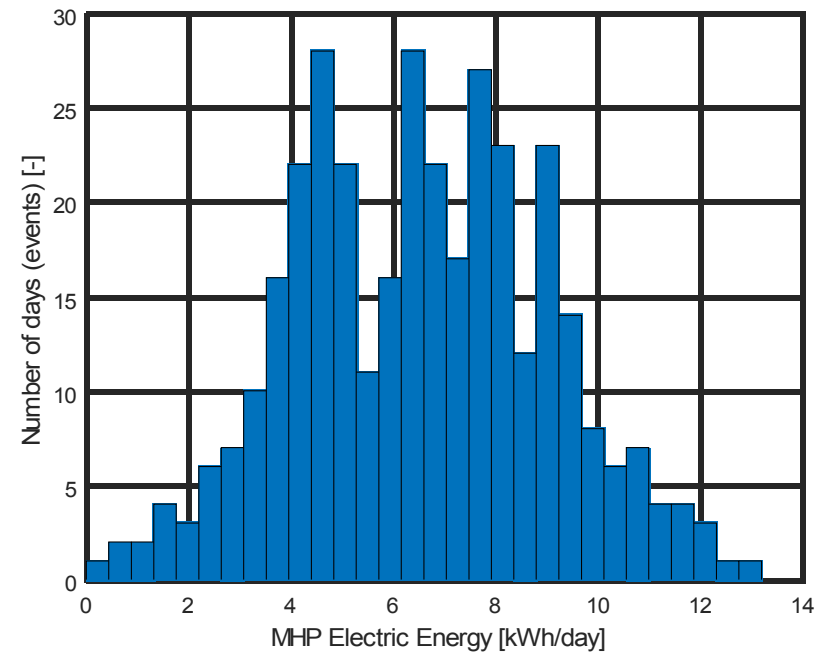

Elec. Flexibility 6,5 kWh/Day average



24 Hr forecast of HBS operation schedule

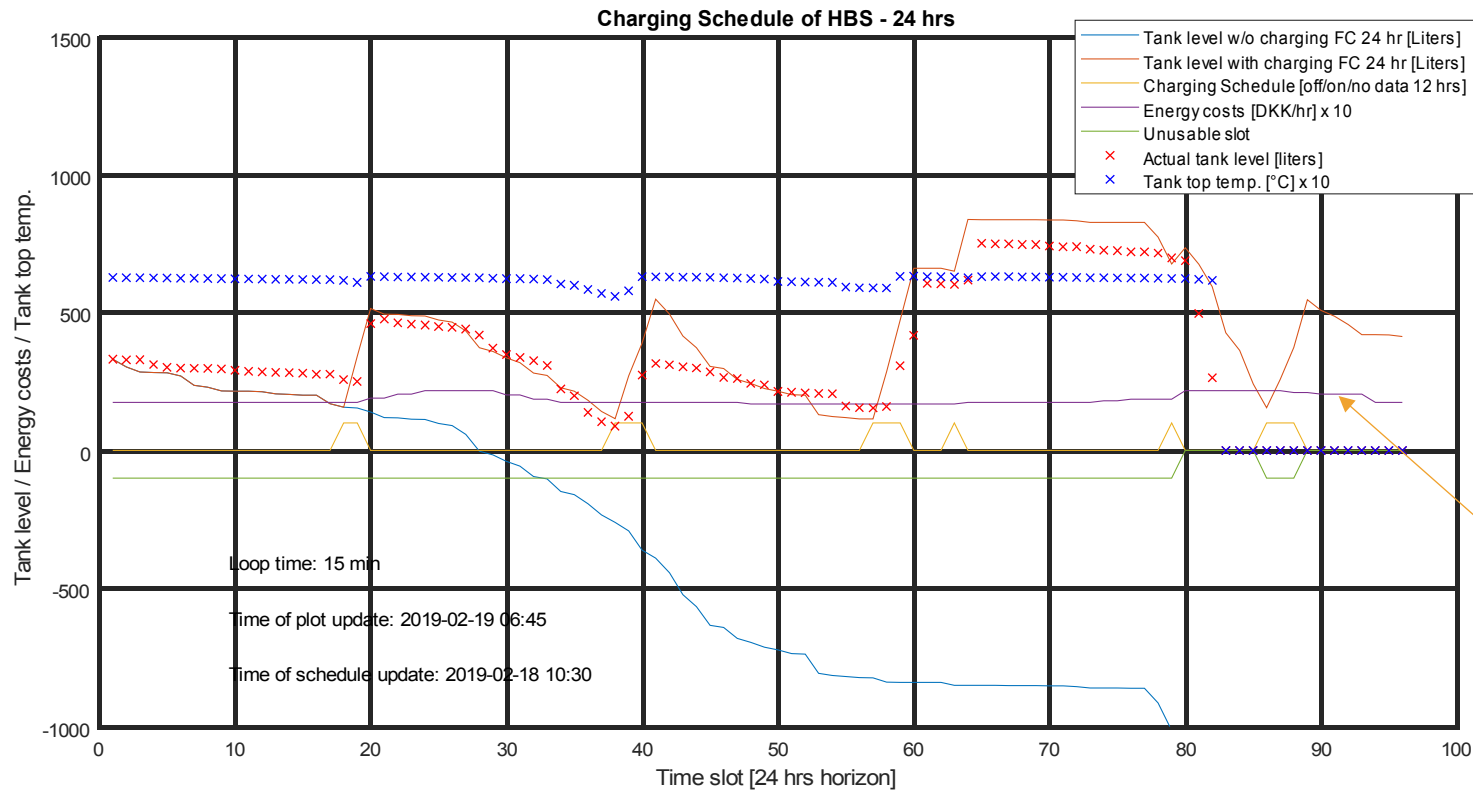

Charge criteria's:

At the lowest energy costs

As late as possible

Within tank charging level constrains (100-1000 liters) usable volume

Usable volume at end 500 Liters

NordPool Elec. Costs
 Simulated Marginal DH Costs



Conclusions

We have realized a Prognosis based scheduling of the HBS, optimizing for lowest energy costs in relation to when to charge the DH tank.

The applied principles are simple but works, they can be improved, e.g. by:

- Use other methods like clustering, pattern recognition
- When forecast is detected “bad” during the day, take action mediately (do not wait until next week)

We will look more into Flexibility 2 and 3 (MHP operation and Source for Circulation HP)

The daily **average DHW load shift** potential is 72 kWh/day for a 22 flat building

-Hereof is electricity 6,5 kWh/day and DH 65,5 kWh/day in average

-Regarding capacity flexibility, this is 3 kW electric and 30 kW DH realized for e.g. a period of 1 hr. and 5 min. before the morning DHW peak and before the evening DHW peak in average over the year.

-Over the year this varies by +/-50% due to DHW seasonal variation

On a yearly basis its at least on the same level as the load shift potential for the heating system !

The implemented automatic scheduling of the HBS operation with the related flexibility is running successfully as a part of the EnergyLabNordhavn project !



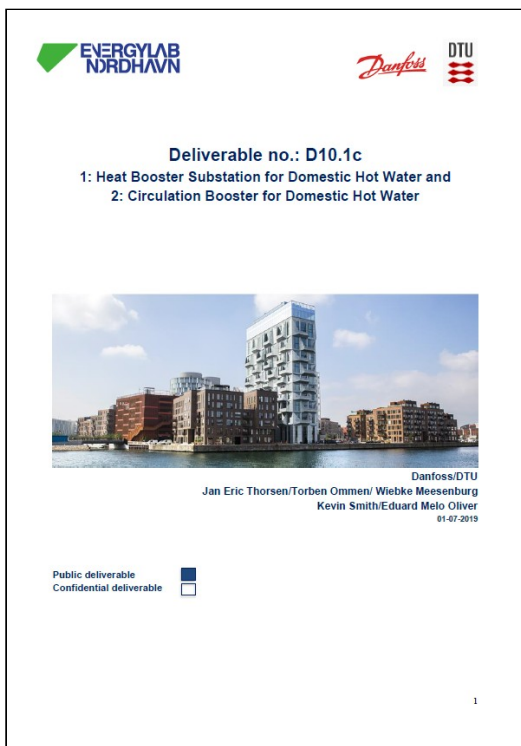

Thank You for the Attention...

And check out www.energylabnordhavn.dk

Jan Eric Thorsen
Director Danfoss Heating Segment Application Centre
jet@Danfoss.com

